

**INTELLIGENT MESSEN!**  
*INTELLIGENT ANALYSIS!*

**ecom**<sup>®</sup>  
English

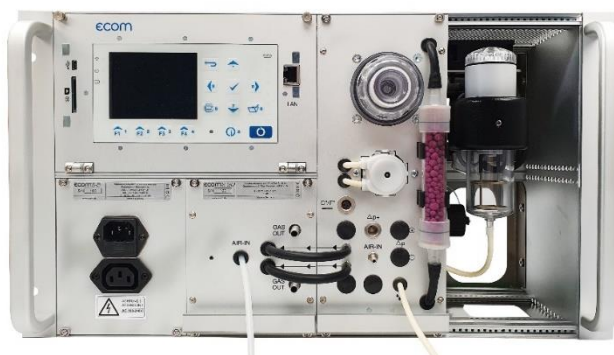

# OPERATING INSTRUCTIONS

# **ecom**<sup>®</sup> ST

# Contents

Intended Use	4
Scope of Delivery	4
General Safety Information	5
1. Device Structure	6
1.1 Components	6
1.2 Connections	8
1.3 Keypad	9
1.4 Interfaces	10
1.4.1 USB	10
1.4.2 RS485	10
1.4.3 Ethernet	13
1.5 Analog outputs (option)	16
1.6 Analog inputs (option)	17
1.7 Unheated gas sampling system	18
1.8 Heated sampling system	18
1.9 Data storage	19
2. Installation	20
2.1 Wall-mounting protective housing (option)	20
2.2 Rack installation	21
3. Starting Up	22
4. Measurement Procedure	22
4.1 Preparation	22
4.2 Flue gas analysis	23
4.3 Measurement screens	24
4.4 Draught measurement	26
4.5 CO overload protection	27
5. Control	27
6. Adjustments	30

6.1 Remote Setup	33
6.1.1 Modbus	33
6.1.2 Time control	35
6.1.3 Configuring the Analog outputs (option)	35
7. Data Processing	37
7.1 Data logger	37
7.2 Data connection to the PC	38
7.2.1 ecom-DAS NT2	38
7.2.2 ecom-DAS 5	39
7.3 ecomModbus	39
8. Maintenance	40
8.1 Fine dust filter	40
8.2 Gas sensors	41
8.3 Calibration	42
8.4 Removal / re-installation of modules	43
8.4.1 Gas measuring module	43
8.4.2 Gas processing module	43
8.5 Probe/Tubing	44
8.6 SBK system (option)	44
Technical Data	45
Disposal	47
FAQ	47

## Intended Use

The ecom-ST is a stationary measuring instrument made by ecom GmbH, which is intended for the semi-continuous exhaust gas measurement at combustion systems and which is permanently installed on site. The device is operated either by the internal time control or by time control via Modbus. A maximum measuring time of 1 hour without interruption is possible. Afterwards, a fresh air purging phase of at least 4 minutes with subsequent fresh air calibration (at least 1 minute) must be carried out. When the internal time control is activated, a data set is saved at the end of the measurement time (see chapter Time control).

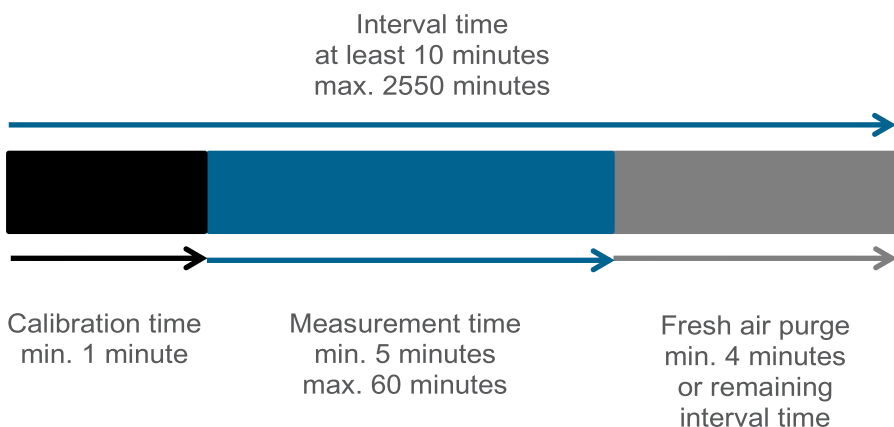

## Scope of Delivery

- ecom-ST
- Mains power cable 2,5 m
- Kit of consumable spares
- Protective housing (option)

# General Safety Information



## WARNING

### **Risk of injury**

Improper work on combustion engines or combustion controllers can lead to injuries.

Work on such systems may only be carried out by specialists.



## WARNING

### **Risk of electric shock**

Live components are exposed when the housing is open. Before opening the device, disconnect it from the power supply voltage.



## CAUTION

### **Damage to the electronics**

Moisture or frost can damage the electronics. Do not store the device in damp rooms or by temperature below 0°C!



## CAUTION

### **Damage to the sensors**

Substances containing solvents damage the device's sensors. Avoid contact with substances containing solvents!



## CAUTION

### **Damage to electronic components**

Electrostatic discharge can damage electronic components. Before touching the inside of the housing, touch a grounded component!

## NOTE

Strong electromagnetic fields can affect the function of the device. Do not expose the device to any strong electromagnetic radiation!

## NOTE

Check fine dust filter and PTFE filter regularly!  
Change filter when the grey staining equals  $<3$  on the soot dot comparison scale!

# 1. Device Structure

## 1.1 Components



1 Device with protective housing (option)

2 Key

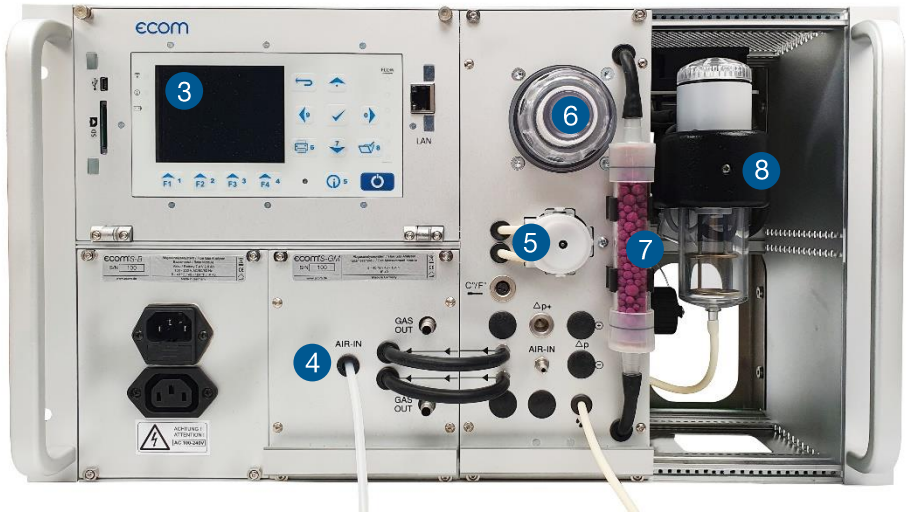

3	Graphic display	7	SO <sub>2</sub> /NO <sub>x</sub> filter for CO sensor
4	Fresh air inlet	8	Gas cooler with fine dust filter

## 1.2 Connections

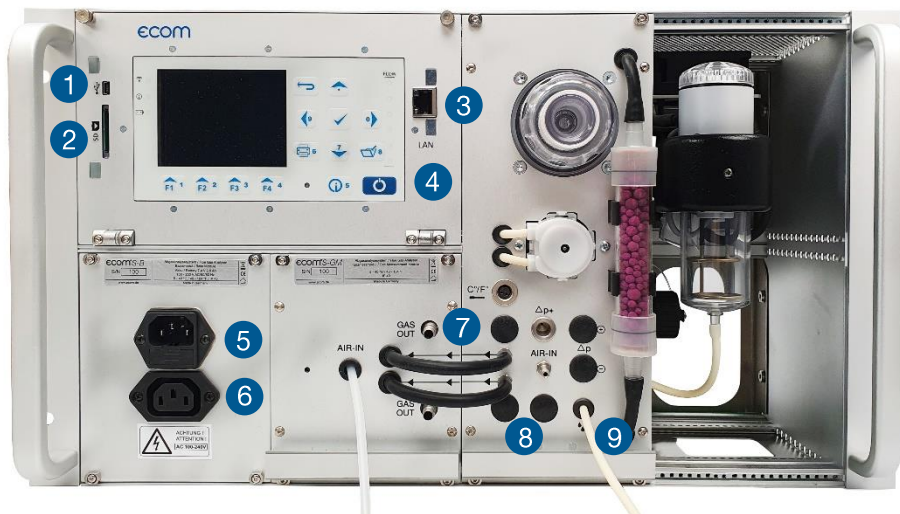

1	USB connection	4	Analog outputs (option)	7	Measuring gas outlet
2	Slot for multi media card (SD)	5	Mains power connection - max. cable length 3 m	8	Analog inputs
3	Network connection	6	Mains supply ventilation fan		Condensation outlet



## 1.3 Keypad



1	Connection LED (only by wireless connection)	5	ESC key (quit/escape menu)	9	Store key
2	Info LED (for indication of instrument status)	6	Digital flow indication/flow meter	10	Info key (access to control menu)
3	Battery LED (for indication of charging status)	7	Enter key (confirm selection)	11	ON/OFF key
4	Function keys (assignment shown on display)	8	Cursor control (up/down/right/left)		

### NOTE

In input mode, the numerical function of the keys is used to enter figures.

## 1.4 Interfaces

### 1.4.1 USB

The device is equipped with an USB interface. The maximum cable length for using the interface is 2 m. The USB port can be used to establish a connection to a PC or laptop. Data can be recorded using the ecom PC software DAS NT 2 or DAS5.

A driver is required for communication between the device and the ecom PC software DAS NT 2 or DAS5. PC software and USB drivers are available free of charge on the ecom GmbH website (see <https://www.ecom.de/en/downloads/>).

The following transmission parameters must be set for the two programs on the ecom-ST ("Adjustments" /" Internal "/" USB "):

#### DASNT2

- 1200 Baud
- Protocol DAS

#### DAS5

- 1200 to 38400 Baud (setting as in software „DAS5“)
- Protocol Enhanced

### 1.4.2 RS485

An RS485 interface is available for connecting the device via Modbus RTU. The ecom-ST supports a 2-wire topology (see figure).

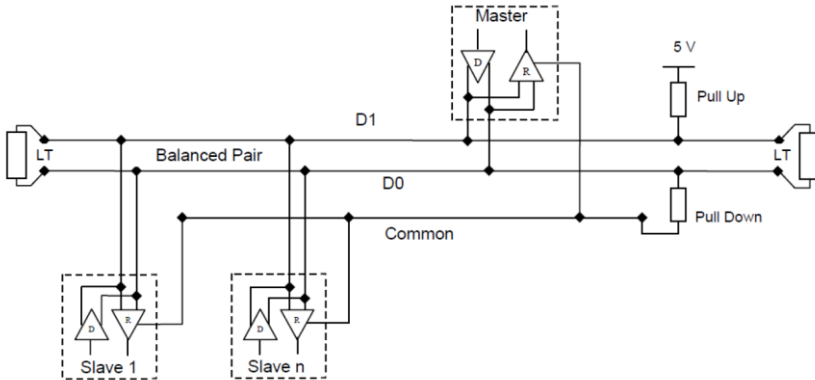

The Modbus slave address is set to 0x2 in the delivery state. The maximum cable length is 50 m. If the ecom-ST is used as a terminal device, a termination of 120  $\Omega$  is provided. The termination is active on delivery. Proceed as follows to deactivate:

1. Disconnect the device from the mains voltage.
2. Loosen the knurled screws on the front panel.
3. Open the front panel.
4. Set DIP switch 3 to OFF.



<b>1</b> Knurled screw	<b>2</b> Front plate	<b>3</b> DIP switch
------------------------	----------------------	---------------------

The cable for the data connection via Modbus RTU can be connected to the 8-pin connector. The plug is then plugged into the socket on the circuit board. The pin assignment is listed below.

**1**

Pin	
1	RS485 A
2	RS485 B
3	
4	
5	
6	
7	
8	GND



<b>1</b>	Pin assignment	<b>3</b>	8-pin socket
<b>2</b>	8-pin plug	<b>4</b>	Position at device

## NOTE

When using the RS485 interface, neither the USB nor the COM module must be set to a Modbus protocol.

### 1.4.3 Ethernet

An Ethernet interface is available for connecting the device via Modbus TCP. The ecom-ST can be integrated into a network via the LAN connection on the front.

The following transmission parameters must be set at the ecom-ST ("Adjustments" / "Internal" / "Ethernet-Modul"):

- 115200 Baud (recommended adjustment)
- Protocol Modbus/TCP

Protocol Modbus/TCP = Protocol with 1 Byte Identifier

Protocol Modbus/TCP (2) = Protocol with 2 Byte Identifier



LAN connection

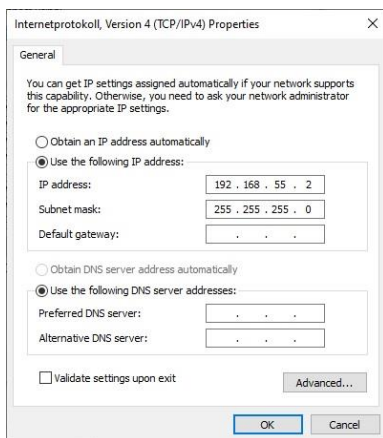

Upon delivery, the ecom-ST has the IP address "192.168.55.1". To change it, you have to configure a PC for this subnet. It is advisable to temporarily configure the PC with the IP address "192.168.55.2".

The ecom-ST has a web interface for configuring the IP address as well as user name and password. To connect, enter the IP address "192.168.55.1" in the web browser (in this example Opera). On delivery, the user name is "admin" and the password is "PASSWORD".

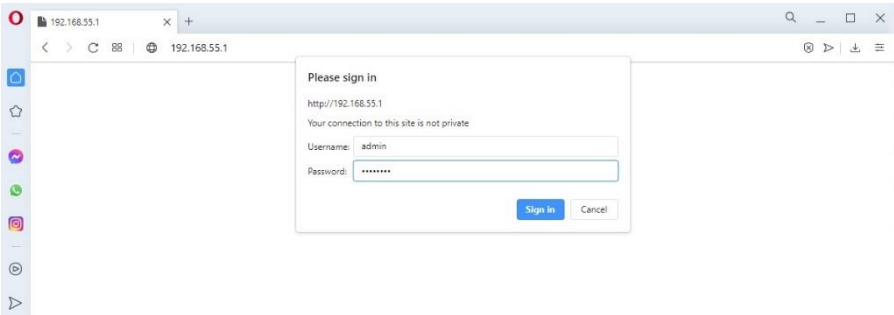

You can set the password for the administrator and for the creation of additional users under the menu item "User".

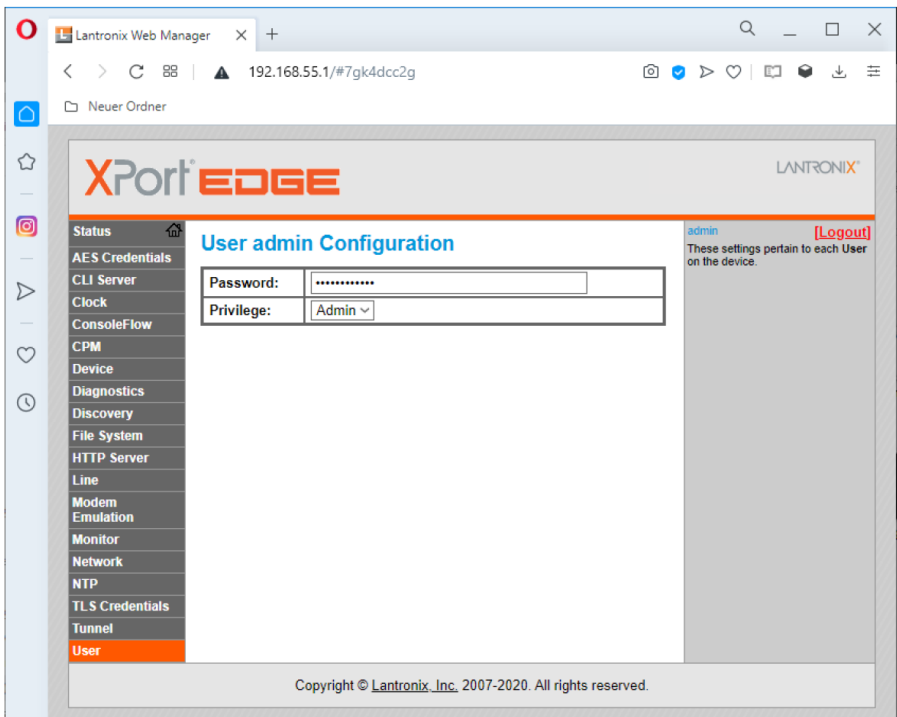

To adapt the network configuration, you can change the network settings under "Network" by selecting "eth0" → "Configuration".

The screenshot shows the Lantronix Web Manager interface. The browser address bar displays '192.168.55.1/#7gk4dklni'. The page title is 'XPort EDGE' and 'LANTRONIX'. The left navigation menu includes options like Status, AES Credentials, CLI Server, Clock, ConsoleFlow, CPM, Device, Diagnostics, Discovery, File System, HTTP Server, Line, Modem Emulation, Monitor, Network (highlighted), NTP, TLS Credentials, Tunnel, and User. The main content area is titled 'Interface eth0 Configuration' and contains a table of settings:

State:	<input checked="" type="radio"/> Enabled <input type="radio"/> Disabled
Hostname:	ecom-S
Priority:	1
MSS:	1460 bytes
DHCP Client:	<input type="radio"/> Enabled <input checked="" type="radio"/> Disabled
IP Address:	192.168.55.1/24
Domain:	
Default Gateway:	<None>
Primary DNS:	<None>
Secondary DNS:	<None>
IPv6 State:	<input checked="" type="radio"/> Enabled <input type="radio"/> Disabled
DHCPv6 Client:	<input checked="" type="radio"/> Enabled <input type="radio"/> Disabled
IPv6 Auto Configuration:	<input checked="" type="radio"/> Enabled <input type="radio"/> Disabled
IPv6 Address:	<None>
IPv6 Default Gateway:	<None>
IPv6 Primary DNS:	<None>
IPv6 Secondary DNS:	<None>

On the right side, there is a user menu for 'admin' with a '[Logout]' link. Below it, a warning states: 'Primary DNS may contain up to 15 characters. For ap0, which has a DHCP Server, the Primary DNS (if present) is placed into DHCP response option 6. If neither the Primary DNS nor Secondary DNS is present in the ap0 configuration, the DHCP Server offers its own simple DNS. Other interfaces refer to the Primary DNS only if DHCP Client is disabled. The Primary DNS is the first choice when performing a Domain Name lookup.'

At the bottom of the page, the copyright notice reads: 'Copyright © Lantronix, Inc. 2007-2020. All rights reserved.'

## 1.5 Analog outputs (option)

The device can be equipped with 8 analog outputs (4 mA - 20 mA). Channels 1 to 4 are available at socket 1 (lower socket) (see pin assignment socket 1). Channels 5 to 8 are available at socket 2 (upper socket) (see pin assignment socket 2).

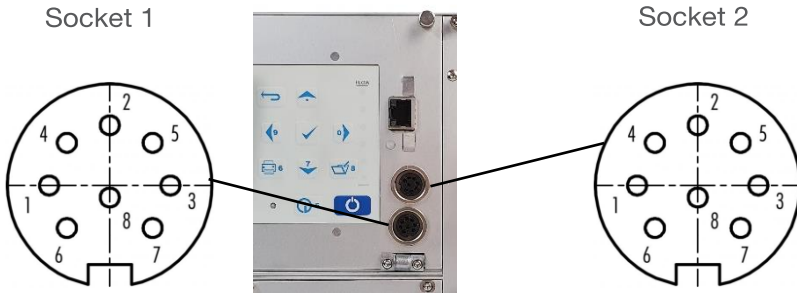

Pin assignment socket 1

1	GND channel 4	4	Signal channel 3	7	GND channel 1
2	Signal channel 4	5	GND channel 2	8	Signal channel 1
3	GND channel 3	6	Signal channel 2		

Pin assignment socket 2

1	GND channel 8	4	Signal channel 7	7	GND channel 5
2	Signal channel 8	5	GND channel 6	8	Signal channel 5
3	GND channel 7	6	Signal channel 6		

Each channel can be assigned a measurement or calculation variable with free scaling (see chapter “Configuring the Analog outputs”).

Technical Data	
R_Load	600 Ohm at I_max
I_max	20 mA
U_L	15 V (open circuit voltage)



## 1.6 Analog inputs (option)

The device can be equipped with 2 analog inputs. The analog inputs are galvanically isolated and can be supplied with signals of 4 mA □ 20 mA or 0 – 10V. A power supply for the signal generators by the ecom-ST is not provided.

Channel 1 is available at socket 1 (left socket) and channel 2 at socket 2 (right socket). The pin assignment is shown in the table below.

Pin Number	Assignment
1	Not assigned
3	Ground
4	Signal

Plug for analog inputs



Analog inputs

## 1.7 Unheated gas sampling system

The ecom-ST can be equipped with a so-called NO<sub>x</sub> tubing. The NO<sub>x</sub> tubing effectively minimizes the washout losses of water-soluble gas components like NO<sub>2</sub> and SO<sub>2</sub>. Thanks to its smooth surface and the increased flow rate, the condensation formation and the correlated washout impact are minimized.



### NOTE

- Do not kink the NO<sub>x</sub> tubing!
- Do not put the NO<sub>x</sub> tubing into water!

## 1.8 Heated sampling system

By using the heated sampling system (option), the measurement of water-soluble target substances (NO<sub>2</sub> and SO<sub>2</sub>) is possible without washout losses. A hot gas filter integrated in the probe head protects the device from premature contamination. The maximum exhaust gas temperature when using the heated sampling system is 500°C.



### NOTE

- Do not kink the heated tubing!
- Do not put the heated tubing into water!
- Clean or change the PTFE filter regularly!

## 1.9 Data storage

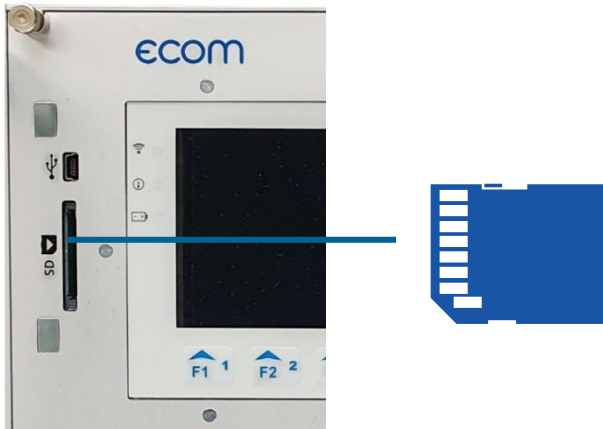

If a SD card is inserted in the device, measurements can be saved. In order to be able to make a recording, the SD card must be inserted into the SD card slot as shown until it clicks into place completely.

### NOTE

The SD card must have the following properties:

- Maximal storage capacity: 32 GB (UHC card)
- Formatting: 16-bit FAT / FAT32



### CAUTION

#### Data loss

Loss of data and damage to the data carrier are possible.

Do not pull out cards while data is being recorded!

All values of a recording are saved in a csv file with the name " ST\_DL-xx.csv ". Successive files are automatically numbered from 00.

## 2. Installation

### NOTE

Fastening material is not included and must be selected on site according to the individual circumstances.

### 2.1 Wall-mounting protective housing (option)

#### Dimensional drawing

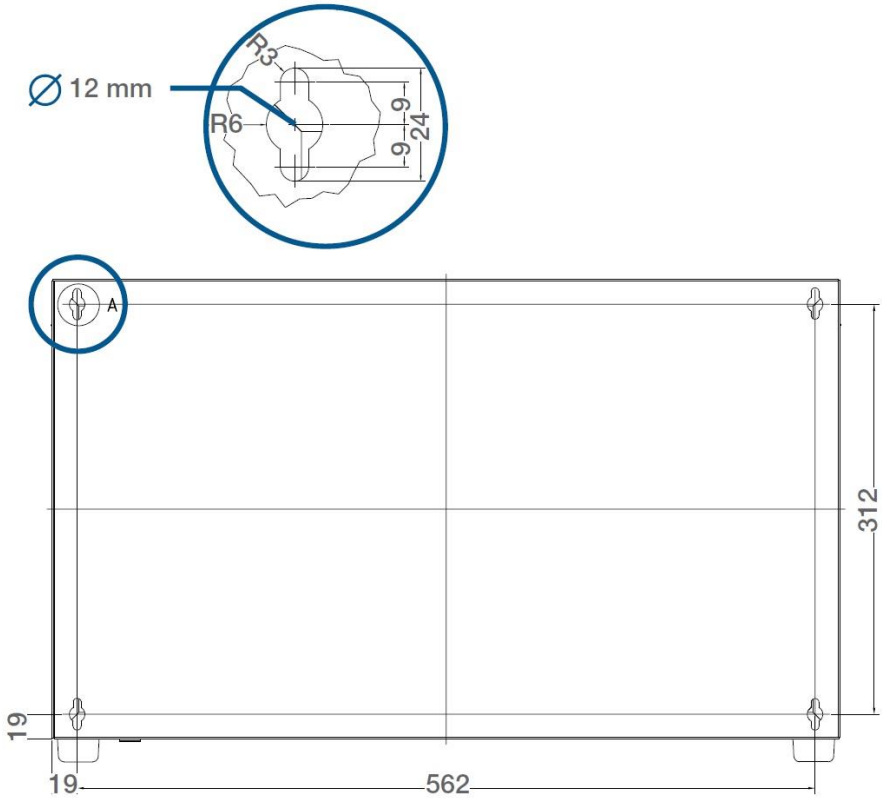

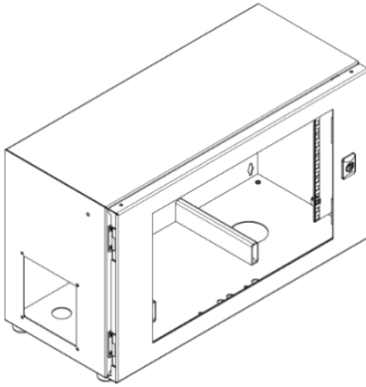

## NOTE

For mounting, kindly consider that the device with the protective housing weighs approx. 25 kg.

Install the device in a ventilated room only!

1. Pre-drill the mounting holes acc. to the dimensional drawing.
2. Depending on the wall and the individual conditions on site, screw the protective housing to the wall.

## NOTE

Do not use the protective housing as a storage space!

## 2.2 Rack installation



## NOTE

6 RU must be complied with!

### 3. Starting Up

1. Connect the gas sampling system to the device.
2. Connect the gas sampling system to the extraction point.
3. Connect the power supply unit.
4. If necessary, connect hose for fresh air supply (AIR-IN Gas processing module).
5. Connect hose for condensate evacuation disposal.
6. Switch on the device.

### 4. Measurement Procedure

#### 4.1 Preparation

#### NOTE

Prior to each measurement, make sure that:

- the device has no visible defects.
- the measuring system is tight.

#### Gas analysis

Settings

Control

Remote setup

After switching on the device, the start screen is shown on the display and then the main menu. In the main menu 4 submenus are displayed.

Menu point	Meaning
Gas analysis	Perform flue gas analysis
Settings	Modify instrument settings
Control	Check operation state of instrument
Remote Setup	Adjust data transfer

## 4.2 Flue gas analysis

To perform measurements, select with the cursor keys the sub menu "Gas analysis" and confirm with <Enter>. The instrument starts a 1 minute calibration phase. If a memory card is inserted, you are asked for internal data processing, which must be answered with <F4> = no (internal data processing with the ecom-ST is irrelevant).

Then the suitable fuel must be selected from a table.

Fuel types:

Fuel oil  
Natural gas  
City gas  
Coke oven gas  
Liquid gas

Fuel type		
Fuel oil		
CO2max	A1	B
15.4	0.50	0.007
Select :	<input checked="" type="checkbox"/> <input checked="" type="checkbox"/>	

Use the cursor keys to select the desired fuel type and confirm with <Enter>.

### Note

In the case of dusty or sooty combustion gases, a gas treatment system must be installed upstream!

## 4.3 Measurement screens

The following measurement screens are available:

### Flue gas analysis 1 + 2

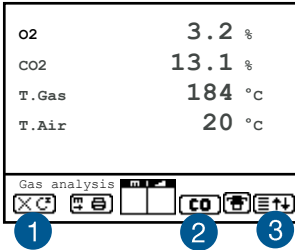

### Flue gas analysis 3

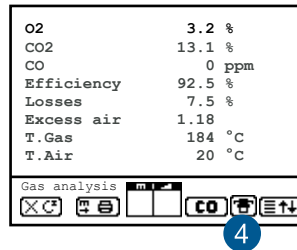

### Flue gas analysis 4

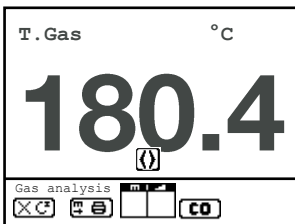

### Draught measurement

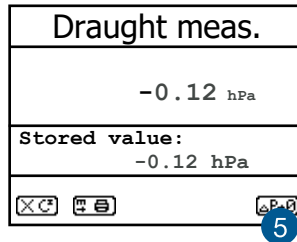

1	Hotkey <F1>	3	Hotkey <F4>	5	Reset zero point draught sensor
2	Switch off CO sensor key <F3>	4	Indication gas cooler switched on		

With <F1> you can switch from the measured value display to a menu item or a function selected previously (see chapter “Adjustments”).

Possible settings are: Fuel type, Eff. (C), Internal, Adjustments, Standby, Purge.

You can also switch to the measured value display from any menu item while pressing <F1>.



The CO sensor can be switched off with <F3> in order to protect it from excessively high concentrations. The automatic switch-off takes place at 2500 ppm or 4000 ppm (depending on the model).

With <F4> it is also possible to switch from the measured value display to a menu item or a function selected previously (see chapter "Adjustments"). Possible settings are: Fuel type, Eff. (C), Internal, Adjustments, Standby, Display values, Purge.

### Adjustment of the measurement screens

#### NOTE



The position of the measured and calculated values (flue gas analysis) can be changed at user's choice.

To change the position of the measured and calculated values in the measurement screens 1 to 3, proceed as follows:

1. Activate the function with <Enter> / "Display values" / <Enter>.
2. Select the desired line with the cursor keys (up / down).
3. Select the desired parameter with the cursor keys (right / left).
4. Repeat the procedure until the change is completed.
5. Deactivate the function with <Enter>.

The measured and calculated values in measurement screen 4 can be set with the cursor keys (right / left).

## 4.4 Draught measurement

<b>Pressure</b>	
Draught	<b>-0.12 hPa</b>
<b>Recorded value:</b>	<b>-0.12 hPa</b>
	

For an exact measurement, it is advisable to recalibrate the sensor as the differential pressure sensor tends to drift due to its sensitivity. Disconnect the draught hose on the device and press <F4>. The sensor is recalibrated. Reattach the draught hose. The display shows the exact measured value, that can be frozen with the <Store> key.

## 4.5 CO overload protection

The CO sensor is protected from overload by the system. If the limit value of 2500 ppm or 4000 ppm (depending on the model) is exceeded at the CO sensor, the additional internal fresh air flushing pump is switched on, which supplies fresh air to the CO sensor.

If the CO overload protection is active, the CO indicator flashes in the status bar of the measurement screen and the status LED <Info> changes from "green" to "red".



### CAUTION

#### Damage to the CO sensor

The CO sensor can be damaged if the opening for the intake of fresh air (AIR-IN) for the CO sensor is obstructed.

The fresh air opening (AIR-IN) must always be free.



When the CO sensor has been sufficiently purged with fresh air (X disappears behind CO) and the measured values are back within the permitted range, the fresh air purging pump is switched off. The CO display in the status bar of the measurement screen no longer flashes and the status LED <Info> changes from "red" to "green".

## 5. Control

The electrochemical sensors for gas analysis are exposed to a process of wear and tear and they do age. In the course of their use, they change their initial values depending on the gas concentration, the duration of exposure to gas and the degree of contamination of the measurement gas. The device monitors the sensors and corrects any deviation. However, if these deviations and thus the measurement error to be expected become too large, a message is displayed. In this case the measuring module has to be exchanged.

The current status values for the sensors are displayed in the "Control" menu. The cursor keys can be used to scroll through the 4 control screens.

Indication	Meaning
Sensor ##### mV	Output voltage of sensor in mV
Battery #,## V	Output voltage of battery
Operation hours	Operation hours since last maintenance
Total operation hrs	Total operation hours
Next unit check	Date of next maintenance
Service tel.	Phone number of next service centre
Program version	Version of instrument firmware
Serial number	Serial number of the instrument
CO purges	Number of active CO switch-offs until now
Error counter	Number of error messages displayed since then

ecom GmbH	O2	19744 mV
Am Großen Teich 2	CO	7 mV
58540 Iserlohn	Batt	8.09 V
Operation hours: 8.45 hrs		
Total : 18.75 hrs		
Next unit check: 01.07.22		
Service tel. :0800-945-5000		
<b>Further Pages:</b> 		

Programmversion:V1.14 08.06.21		
Serial no. :ST-0001		
CO purges :15		
Error counter :21		
Operation hours: 8.45 hrs		
Total : 18.75 hrs		
Next unit check: 01.07.22		
Service tel. :0800-945-5000		
<b>Further Pages:</b> 		

Indication	Meaning
Last service (history)	The last maintenances of the device are listed: date of maintenance, operating hours at the maintenance time.

Last service (history)	
19.08.2017	88 hrs
25.08.2018	145 hrs
14.08.2019	205 hrs
23.08.2020	322 hrs
--.---.---	
--.---.---	

**Further Pages:** 

Indication	Meaning
Sensor information	Information as to age and calibration data of the sensors.

A5F+	5BNF	5ND
<b>0239839252</b>	<b>0239354496</b>	<b>0339616409</b>
Sensor 10.12.20 Cal 13.01.21 Last Cal 29.03.21	Sensor 10.12.20 Cal 13.01.21 Last Cal 13.01.21	Sensor 10.12.20 Cal 13.01.21 Last Cal 13.01.21
ppm max 20 ppm/h x1000 0	ppm max 1 ppm/h x1000 0	ppm max 224 ppm/h x1000 0

**Further Pages:** 

## 6. Adjustments

Adjustments	
Alignment	
Unit	
Second unit	
Ref. O <sub>2</sub>	
Fuel type	
Select:	
Set clock	
Internal	

In addition to the functions of the device already described, various settings can be made in the measuring device that affect the measuring procedures, the functionality or the output and display of measured values.

Parameter	Meaning	Adjustment field
Alignment	Calibration of the sensors	See chapter calibration
Unit	Conversion for the display of the gas concentration on the measurement screen	ppm mg/m <sup>3</sup> mg/kWh(undiluted) mg/MJ (undiluted) ppm (undiluted) mg/m <sup>3</sup> (undiluted)
Second unit	Second conversion of the gas concentration that can be displayed on the measurement screen	As under „Unit“
Reference O <sub>2</sub>	O <sub>2</sub> oxygen reference	0,0 – 21,0 %
Fuel type	Change of the set fuel type	Country-specific
Clock set	Adjustment of internal clock	
Internal	Sub-menus for further adjustments -- see following table --	

### NOTE

The units mg/kWh and mg/MJ are always calculated and displayed with a reference oxygen content = 0 %.

## NOTE

The specification "undiluted" denotes the conversion of the gas concentration to a definable reference oxygen content according to the following formula:

$$E_{\text{ref}} = E_{\text{meas}} * \frac{21 - O_{2\text{ref}}}{21 - O_{2\text{meas}}}$$

$E_{\text{ref}}$  = Value converted to reference  $O_2$   
 $E_{\text{meas}}$  = measured value  
 $O_{2\text{ref}}$  = reference  $O_2$   
 $O_{2\text{gem}}$  = measured  $O_2$  value

The following settings are available in the Settings / Internal menu:

Parameter	Meaning	Adjustment field
Key beep	Activation / deactivation of the acoustic signal when a button is pressed	Yes, No
Language: ###	Language adjustment	Country-specific
Colour scheme	Setting of the colours used	4 schemes to choose from
F1 Hotkey	Assignment of the link with the <F1> key	See chapter „Measurement Screens“
F4 Hotkey	Assignment of the link with the <F4> key	See chapter „Measurement Screens“
Values options	Setting as to the values ETA, lambda and temperature	All setting channels in the table on the following page
USB	Settings for the USB interface	All settings in the table on the following page
COM module	Settings for the COM interface	All settings in the table on the following page

The following settings are available in the Settings / Internal / Values options menu:

Parameter	Meaning	Adjustment field
Temperature	Not possible by all instruments	°C or °F
Exc. air	Excess air	Ratio or %
Eff. (C)	Efficiency with or without condensate gain	ON, OFF

The following settings are available in the Settings / Internal / USB menu:

Parameter	Adjustment field
Transfer speed	1200 – 115200 Baud
Protocol	Enhanced = DAS 5 DAS = DAS NT 2 Modbus RTU Modbus / TCP Modbus / TCP (2) ---- = none

The following settings are available in the Settings / Internal / COM module menu:



Parameter	Adjustment field
Transfer speed	1200 – 115200 Baud
Protocol	Enhanced = DAS 5 DAS = DAS NT 2 Modbus RTU Modbus / TCP Modbus / TCP (2) ---- = none

## NOTE

Only one Modbus application can be active, either Modbus RTU via RS485 or Modbus / TCP via Ethernet.



## 6.1 Remote Setup

Remote Setup	
Modbus Info	
Modbus Setup	
Auto timing	
Analog output	
Datalogger	
Select:	 

Modbus, time control and analog outputs (option) can be configured in the Remote Setup menu. The menu item “Modbus Info” enables the control of the Modbus data sent and received. The menu item “Data logger” can be used to record measured values on a memory card.

### 6.1.1 Modbus

#### Info

The following information is available:

Indication	Meaning	Example
TxD buffer	Received data	See ecomModbus
RxD buffer	Sent data	See ecomModbus
Device address	ecom-ST device address	Standard setting 2

#### Setup

The following settings can be made:

Parameter	Meaning	Setting change
Device address	Change of the ecom-ST device address for Modbus RTU	Entry after activation with Enter
Current values	Define assignment of measured value - memory address: 1. Address 0x3000 2. Address 0x3001 etc.	Selection with cursor keys Possible measurement values, see next table
Stored values	Define assignment of measured value - memory address: 1. Address 0x2000 2. Address 0x2001 etc.	Selection with cursor keys Possible measurement values, see next table

No.	Measured value	Meaning
1	T.Air	Air temperature in °C
2	T.Gas	Flue gas temperature in °C
3	T.Sensor	Sensor temperature in °C
4	O <sub>2</sub>	Oxygen content in vol. %
5	CO	Carbon monoxide content in ppm
6	NO	Nitric oxide content in ppm
7	NO <sub>2</sub>	Nitrogen dioxide content in ppm
8	SO <sub>2</sub>	Sulphur dioxide content in ppm
9	H <sub>2</sub>	Hydrogen content in ppm
10	H <sub>2</sub> S	Hydrogen sulfide content in ppm
11	C <sub>x</sub> H <sub>y</sub>	Unburned hydrocarbons in vol.%
12	CO <sub>2</sub>	Carbon dioxide content in vol. %
13	Eta	Combustion efficiency in %
14	Losses	Gas losses in %
15	Lambda	Excess air as a ratio or in%
16	Air pressure	Ambient pressure in hPa
17	Draught/ΔP	Pressure in chimney in hPa
18	CO	Carbon monoxide content (adjusted unit)
19	NO	Nitrogen monoxide content (adjusted unit)
20	NO <sub>2</sub>	Nitrogen dioxide content (adjusted unit)
21	SO <sub>2</sub>	Sulphur dioxide content (adjusted unit)
24	CO	Carbon monoxide content (adjusted 2 <sup>nd</sup> unit)
25	NO	Nitrogen monoxide content (adjusted 2 <sup>nd</sup> unit)
26	NO <sub>2</sub>	Nitrogen dioxide content (adjusted 2 <sup>nd</sup> unit)
27	SO <sub>2</sub>	Sulphur dioxide content (adjusted 2 <sup>nd</sup> unit)
28	NO <sub>x</sub>	Total nitrogen oxide content in ppm
29	NO <sub>x</sub>	Total nitrogen oxide content (adjusted unit)
30	NO <sub>x</sub>	Total nitrogen oxide content (adjusted 2 <sup>nd</sup> unit)
31	Stat:	Not used
32	I.Flow	Gas flow I l/min
33	CH1	Analog input 1
34	CH2	Analog input 2

Measured value No. 18 – 34 only available at current values

## 6.1.2 Time control



### CAUTION

#### Invalid measurement results

Sensor drift phenomena lead to higher inaccuracies.

Use the device only with time control!

The following settings can be made:

Parameter	Meaning	Adjustment change
Interval time	Total time per cycle	Entry after activation with Enter: 10 to 2550 minutes
Measuring time	Time during which the measured values are available. At the end of the measuring time, a data record is saved under 0x2000 and following.	Entry after activation with Enter: 5 to 60 minutes
Automatic	Switching on the automatic mode. Operation without time control is not permitted.	ON / OFF after activation with Enter

## 6.1.3 Configuring the Analog outputs (option)

### Gas analysis

### Adjustments

### Control

### Remote setup

```

31 Stat:
 2 T.Gas  20.0  400.0 °C
12 CO2   0.00  20.00 %
 4 O2    0.00  5.00 %
 5 CO     0      500 ppm
 6 NO     0.0   100.0 ppm
 7 NO2    0.0   10.0 ppm
28 NOx   0.0   100.0 ppm
    
```



1. Switch on instrument.
2. Select "Remote setup" with Enter.
3. Select "Analog outputs" with Enter.
4. Select desired value with cursor keys (left/right).
5. Confirm with Enter.
6. Input 4 mA value via numerical keys.
7. Confirm with Enter.
8. Input 20 mA value via numerical keys.
9. Confirm with Enter.

The status of the device can also be queried via the analog outputs (31 Stat :). It is only possible to assess whether the measured values are valid in connection with the status of the device. The table below lists all possible statuses.

Analog value	Meaning
4 mA	Device error
6 mA	Calibration phase not finished
7 mA	Device on standby
8 mA	Sample gas pump off
9 mA	Fresh air purging active
10 mA	Device in measuring mode, but the CO sensor is switched off
20 mA	Device in measuring mode

#### NOTE

Valid measured values are only available if the status is 20 mA.

# 7. Data Processing

## 7.1 Data logger

NOTE
The data logger can only be used if an SD card is inserted in the device.

When an SD card is inserted in the device, a data logger recording can be carried out. Depending on the set recording interval, the measured values are saved one after the other on the SD card and combined in a file with the \* .csv format. The measured values can be evaluated using MS Excel or OpenOffice CALC.

The following settings can be made in the Data processing / Data logger menu:

Parameter	Meaning	Adjustment field
Data logger	Start/Stop	Yes, No
Storage time	Recording interval	1 s – 999 s
CSV header	Setting whether column headings are included in the CSV file	ON, OFF

When the data logger gets active or becomes active again after an interruption, a new file is created on the SD card in which all subsequent measured values of the recording are saved. The files have a predefined name and are numbered consecutively.

### Example:

- ST\_DL-00.csv → oldest file
- ST\_DL-01.csv
- ST\_DL-02.csv
- ST\_DL-xx.csv → latest file

## 7.2 Data connection to the PC

If the device is connected to a PC, measured values can be recorded with PC software from ecom.

The following software solutions are available:

- ecom-DAS NT 2
- ecom-DAS 5

### 7.2.1 ecom-DAS NT2

In addition to the data logger recording, the data can also be transferred directly to the PC software "ecom-DAS NT 2" while the measuring operation is running.

The USB interfaces can be used for communication with the software. The transmission speed and the protocol are predefined for smooth communication between the device and the DAS NT 2 PC software via the USB interface.

To enable communication with the DAS NT 2 PC software, the following settings must be made in the Settings / Internal / USB menu:

Parameter	Adjustment field	Adjustment for DAS NT 2
Transfer speed	1200 Baud – 115200 Baud	1200 Baud
Protocol	DAS = DAS NT 2 Enhanced = DAS 5 ---- = none	DAS

#### NOTE

A driver is required for the communication between the device and the DAS NT 2 PC software via the USB interface.

Download under: <https://www.ecom.de/en/downloads/>

## 7.2.2 ecom-DAS 5

The software "ecom-DAS 5" can be used for the display and logging of measured values and measured value progressions. Measurement data can be exchanged between the software and the device via the SD card. A recording of point measurements and course measurements during the measuring operation can be implemented via USB.

The transmission speed and the protocol are predefined for smooth communication between the device and the DAS 5 PC software via the USB interface.

Parameter	Adjustment field	Adjustment for DAS 5
Transfer speed	1200 Baud – 115200 Baud	1200 Baud – 38400 Baud
Protocol	DAS = DAS NT 2 Enhanced = DAS 5 ---- = none	Enhanced

### NOTE

A driver is required for the communication between the device and the DAS 5 PC software via the USB interface.

Download under: <https://www.ecom.de/en/downloads/>

## 7.3 ecomModbus

To integrate the ecom-ST into your existing software, please use the ecomModbus documentation.

## 8. Maintenance

To ensure the accuracy of your measuring device, we recommend to have the modules checked annually by an authorized partner of ecom GmbH. In case of heavy use, shorter inspection intervals should be considered. Just contact your ecom partner this regarding!

### NOTE

If sensors or probes from other manufacturers are used, the TÜV approval of the device is no longer valid!

Only use sensors or probes provided by ecom GmbH or from an ecom-authorized service center!

### NOTE

If service work is not carried out by ecom GmbH or a service center authorized by ecom GmbH, the warranty for the device expires with immediate validity!

### 8.1 Fine dust filter



Cover cap

The fine dust filter should be checked regularly as follows:

1. Unscrew the cover cap.
2. Check the condition of the fine dust filter.
3. Screw the cover cap back.

### NOTE

The fine dust filter should be changed when the grey colour value corresponds to  $<3$  of the soot comparison scale.



## 8.2 Gas sensors

The gas sensors are calibrated with fresh air as the reference gas each time the device is switched on. New sensors age in the course of use due to wear and tear of the reagents (oxygen sensor) and due to contamination or exposure to concentrations above the nominal measuring range (toxic sensors).

The condition of the sensors is permanently monitored by the device. In the "Control" menu, the values for the output voltage of each installed gas sensor can be checked. The reference values of the sensors are:

Sensor	Reference value output voltage
O <sub>2</sub>	12000 mV
Others	0 mV ( $\pm 150$ mV)

### NOTE

The O<sub>2</sub> sensor must display a value >7000 mV. If this is not the case, the sensor must be replaced. Contact the ecom service centre next to you!

### NOTE

If an error message occurs during the calibration phase, a further calibration phase can help to calibrate the sensors sufficiently. If the error message persists, the device must be checked.

### NOTE

The CO sensor is protected from high concentrations by overload protection (see chapter "CO overload protection").

## 8.3 Calibration

The sensors can be calibrated by using the menu "Adjustments" / "Calibr. sensors". When the calibration menu is selected, the device switches to the Air-IN gas input on the gas processing module. Here the calibration gas must be applied without pressure. Proceed as follows:

### -CO / NO / NO2 / SO2 calibration

(Important: Span gas must get pressure-free to the instrument!)

- Flow with span gas
- Wait for stabilisation of value
- By drift press <Enter>
- Set correct value with number keys
- Confirm input with <Enter>

### -T. Gas / T. Air calibration

- Create reference temperature
- By drift press <Enter>
- Set correct value with number keys
- Confirm input with <Enter>

<b>Span gas used by ecom</b> (approximate value):	
<b>Sensor</b>	<b>Span gas</b>
CO;O2	400 ppm CO with 2% O2 rest N2
NO	90 ppm NO rest N2
NO2	90 ppm NO2 rest synthetic air
SO2	100 ppm SO2 rest N2
CO%	3% CO rest N2

## 8.4 Removal / re-installation of modules

### 8.4.1 Gas measuring module

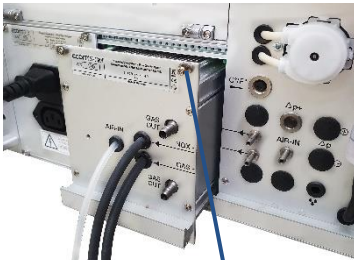

Hoses

Screw

#### Removal

1. Pull off the hoses.
2. Loosen the 4 screws fixing the gas measuring module.
3. Pull the gas measuring module out of the device.

#### Reinstallation

1. Insert gas measuring module into device.
2. Tighten the 4 screws.
3. Push the hoses onto the turned parts.

### 8.4.2 Gas processing module



Hoses

Screw

#### Removal

1. Pull off the hoses.
2. Loosen the 4 screws.
3. Pull the gas processing module out of the device.

#### Reinstallation

1. Insert gas processing module into the device.
2. Tighten the 4 screws.
3. Slip the hoses over the turned parts.

## 8.5 Probe/Tubing

Depending on how the device is used, the probe and hose should be cleaned regularly in order to remove particle deposits and prevent premature wear due to corrosion. The hose can be cleaned after loosening all plug connections on the device and on the probe handle.

The O-rings of the hose connections should occasionally be lightly greased with acid-free lubricant.



### CAUTION

#### **Damage to the device / transport system**

The hot flue gas probe can damage the device or the transport system if it comes in contact with.

Let the probe cool down before storing!

## 8.6 SBK system (option)

The PTFE filter in the probe head should be changed regularly.

# Technical Data

Measured values		Range	Accuracy
O <sub>2</sub>	EC	0 vol. % – 21 vol. %	±0,3 vol. %
CO	EC	0 ppm – 4000 ppm	±20 ppm / 5 % MV*
CO H <sub>2</sub> - comp.	EC	0 ppm – 10.000 ppm	±20 ppm / 5 % MV*
CO%	EC	0 ppm – 63.000 ppm	±100 ppm / 5 % MV*
NO	EC	0 ppm – 5000 ppm	±5 ppm / 5 % MV*
NO Extra Low	EC	0 ppm – 300 ppm	±2 ppm / 5 % MV*
NO <sub>2</sub>	EC	0 ppm – 1000 ppm	±5 ppm / 5 % MV*
NO <sub>2</sub> Low	EC	0 ppm – 100 ppm	±5 ppm / 5 % MV*
SO <sub>2</sub>	EC	0 ppm – 5000 ppm	±10 ppm / 5 % MV*
SO <sub>2</sub> Low	EC	0 ppm – 100 ppm	±5 ppm / 5 % MV*
H <sub>2</sub>	EC	0 ppm – 20.000 ppm	±100 ppm / 5 % MV*
H <sub>2</sub> S	EC		±10 ppm / 5 % MV*
CO <sub>2</sub>	IR	0 vol.% – 20 vol.%	±0,5 vol. % / 5 % MV*
CO <sub>2</sub>	IR	0 vol.% – 100 vol.%	±5 vol. %
CH <sub>4</sub>	IR	0 vol.% – 5 vol.%	±0,2 vol. % / 5 % MV*
C <sub>x</sub> H <sub>y</sub>	K	0 vol.% – 4 vol.%	
T-Gas	T	0 °C – 500 °C	±2 °C / 1,5 % MV*
T-Air	PT	0 °C – 99 °C	±1 °C
Δ pressure	D	0 hPa – ± 100 hPa	±0,5 hPa / 1 % MV*
Air pressure	D	300 hPa – 1100 hPa	±2 hPa

EC = Electrochemical sensor

IR = Infrared sensor

K = Catalytic Sensor

T = Thermocouple NiCr-Ni

PT = PT 2000

D = DMS bridge

MV\* = Measured value (higher value prevails)

Calculated values	Range	Principle
CO <sub>2</sub>	0 – CO <sub>2max</sub>	Calculation
Efficiency (ETA)	0 % – 120 %	Calculation
Losses	0 % – 99,9 %	Calculation
Excess air (Lambda)	1 – ∞	Calculation
Dew point	x °C	Calculation
mg/m <sup>3</sup>	x mg/m <sup>3</sup>	Calculation
mg/kWh	x mg/kWh	Calculation
O <sub>2</sub> reference	x % O <sub>2</sub>	Calculation

Further data	
Power supply	110 V – 230 V AC, internal battery 7,4 V 3,45 Ah
Ambient temperature	+5°C – +40°C
Air humidity	max. 90 % rH, non-condensing
ecom-ST	
Dim. (W x H x D)	Approx. 483 (19“) mm x 266 (6HE) mm x 196 mm
Weight	Approx. 8,6 kg
Protective housing	(option)
Dim. (W x H x D)	Approx. 600 mm x 350 mm x 265 mm
Weight	ecom-ST with protective housing approx. 25 kg

## NOTE

Subject to technical changes! (Status 01 2025)

# Disposal



- Take used batteries to the designated collection points!
- Dispose of packaging material in an environmentally friendly manner!
- Used devices must be disposed of in an environmentally friendly manner by an authorized agency.

## NOTE

On request, we can take back used devices and dispose of them in an environmentally friendly manner.

# FAQ

Where can I find important instrument information?	Important device information can be called up with the Info button (Control menu):: <ul style="list-style-type: none"> <li>• Serial number</li> <li>• Service phone number</li> <li>• Sensor voltages</li> <li>• Sensor information</li> <li>• Error counter</li> <li>• Operation hours etc.</li> </ul>
The instrument shows the error message "O2 sensor mV too low"	The sensor module must be replaced.
The instrument shows the error message "xx sensor mV too high"	The sensor module must be replaced.

## EG-Konformitätserklärung | EC Declaration of Conformity

Hiermit erklärt der Hersteller  
The manufacturer

**ecom GmbH**  
Am Großen Teich 2  
D-58640 Iserlohn, Germany



in alleiniger Verantwortung für die Ausstellung dieser Erklärung, dass die nachfolgend aufgeführten Produkte:  
hereby declares under its sole responsibility, that the products

**Abgasanalysegeräte / flue gas analysis devices**

Type: ecom-B

ecom-J2KNpro

ecom-CL2/ B+

ecom-J2KNpro IN / -J2KNpro INS

ecom-D

ecom-J2KNpro TECH

ecom-EN3

ecom-ST

allen einschlägigen Bestimmungen der folgenden EU-Richtlinien entsprechen:  
comply with the following European Directives:

2014/53/EU      **Funkanlagenrichtlinie / Radio Equipment Directive**  
2011/65/EU      **RoHS**  
2014/35/EU (\*)   **Niederspannungsrichtlinie / Low Voltage Directive (\*)**

(\*): Gilt nur für Geräte mit 230 V Eingangsspannung / applies only to devices with 230 V input voltage

Folgende Normen wurden angewendet:  
The following standard/s were used:

EN 61010-1:2010/A1:2019	Sicherheitsbestimmungen für elektrische Mess-, Steuer-, Regel- und Laborgeräte <i>Safety requirements for electrical equipment for measurement, control, and laboratory use</i>
EN 300 328 V2.2.2	Breitband-Übertragungssysteme - Datenübertragungsgeräte zum Betrieb im 2,4-GHz-Band <i>Wideband transmission systems - Data transmission equipment operating in the 2,4 GHz band</i>
ETSI EN 301 489-1 V2.2.3	Elektromagnetische Verträglichkeit (EMV) - Standard für Funkeinrichtungen und -dienste – <i>ElectroMagnetic Compatibility (EMC) standard for radio equipment and services</i>
ETSI EN 301 489-17 V3.2.4	Elektromagnetische Verträglichkeit (EMV) für Funkeinrichtungen und -dienste - Teil 17: Spezifische Bedingungen für Breitbanddatenübertragungssysteme <i>ElectroMagnetic Compatibility (EMC) standard for radio equipment and services - Part 17: Specific conditions for Broadband Data Transmission Systems</i>
EN 61326-1:2013	Elektrische Mess-, Steuer-, Regel- und Laborgeräte - EMV-Anforderungen <i>Electrical equipment for measurement, control and laboratory use – EMC requirements</i>
EN 50270:2015/AC:2016-08	Elektromagnetische Verträglichkeit - Elektrische Geräte für die Detektion und Messung von brennbaren Gasen, toxischen Gasen oder Sauerstoff <i>Electromagnetic compatibility - Electrical apparatus for the detection and measurement of combustible gases, toxic gases or oxygen</i>
EN IEC 63000:2018	Technische Dokumentation zur Beurteilung von Elektro- und Elektronikgeräten hinsichtlich der Beschränkung gefährlicher Stoffe <i>Technical documentation for the assessment of electrical and electronic products with respect to the restriction of hazardous substances</i>

Iserlohn, 25.07.2022

  
 Matthias Platte (Geschäftsführer / Managing Director)



## Declaration of Conformity

The manufacturer

ecom GmbH  
Am Großen Teich 2  
D-58640 Iserlohn, Germany



hereby declares under its sole responsibility, that the products

**Flue gas analysis devices**

Type: ecom-B	ecom-J2KNpro
ecom-CL2/B+	ecom-J2KNpro IN / INS
ecom-D	ecom-J2KNpro TECH
ecom-EN3	ecom-ST

comply with the following European Directives:

**Radio Equipment Regulations 2017**  
**The Restriction of the Use of Certain Hazardous Substances in Electrical and Electronic Equipment Regulations 2012 (RoHS)**  
**Electrical Equipment (Safety) Regulations 2016 (\*)**

(\*): applies only to devices with 230 V input voltage

The following designated standards / other technical standards and specifications were used:

EN 61010-1:2010/A1:2019	Safety requirements for electrical equipment for measurement, control, and laboratory use
EN 300 328 V2.2.2	Wideband transmission systems - Data transmission equipment operating in the 2,4 GHz band
ETSI EN 301 489-1 V2.2.3	ElectroMagnetic Compatibility (EMC) standard for radio equipment and services
ETSI EN 301 489-1 V3.2.4	ElectroMagnetic Compatibility (EMC) standard for radio equipment and services - Part 17: Specific conditions for Broadband Data Transmission Systems
EN 61326-1:2013	Electrical equipment for measurement, control and laboratory use – EMC requirements
EN 50270:2015/AC:2016-08	Electromagnetic compatibility - Electrical apparatus for the detection and measurement of combustible gases, toxic gases or oxygen
EN IEC 63000:2018	Technical documentation for the assessment of electrical and electronic products with respect to the restriction of hazardous substances

Iserlohn, 12.10.2022

  
Matthias Platte (Geschäftsführer / Managing Director)

INTELLIGENT MESSEN!  
MEASURE WITH INTELLIGENCE!



**ecom GmbH**

Am Großen Teich 2  
D-58640 Iserlohn

[Info@ecom.de](mailto:Info@ecom.de)

[www.ecom.de](http://www.ecom.de)

Phone: +49 2371 945-5

Fax: +49 2371 40305

UK importer:

**DRM Technic Ltd.**

Unit 25 Raleigh Hall Industrial Estate,  
Stafford, Staffordshire, ST21 6JL, UK

[sales@drmtechnic.com](mailto:sales@drmtechnic.com)

[www.drmtechnic.com](http://www.drmtechnic.com)

Phone: +44 (0) 1785 556 593